

RCCN 日成PHC型插鞘式扎线固定座 Push Tie Mounts

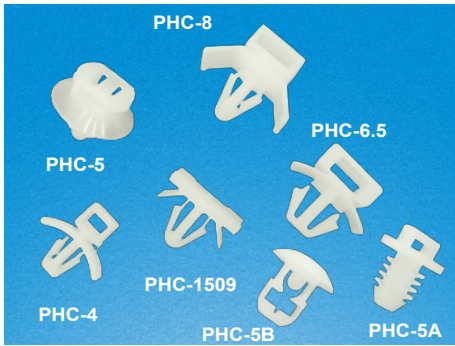

*为常规现货品。 * means common items

单位/Unit:mm

型号 Item No.		带孔 T	基板孔 Fiting	包装 Packing
本色/Natural	黑色/Black			
* PHC-4	PHC-4B	4.0	4.8	100pcs
PHC-5		5.0	7.6	
PHC-5A		5.0	6.4	
PHC-5B		5.0	6.4	
* PHC-6.5	PHC-6.5B	6.5	8.5	
* PHC-8	PHC-8B	8.1	6.2	
PHC-9		9.4	7.9	
PHC-1105		11	4.5	
PHC-1509		7.8	4.5	

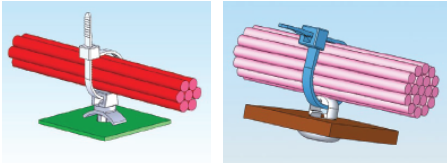

PHC-4/6.5/8

PHC-5B

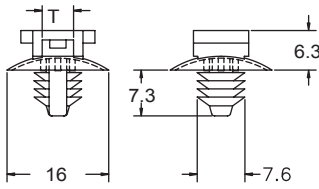
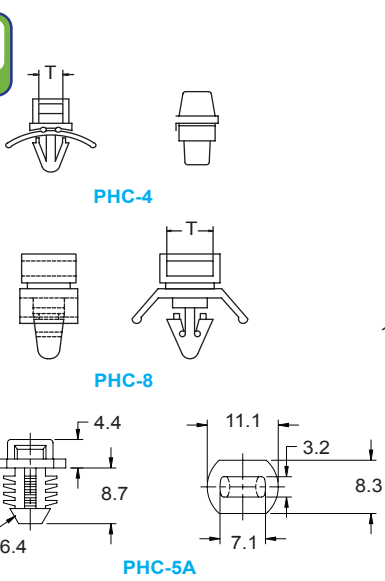

PHC-5

*为常规现货品。 * means common items

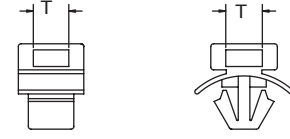

PHC-6.5

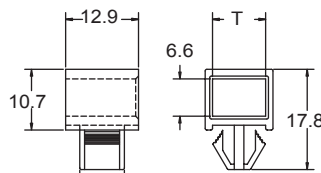

PHC-9

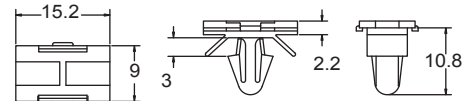

PHC-1509

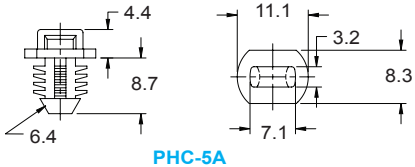

PHC-5A

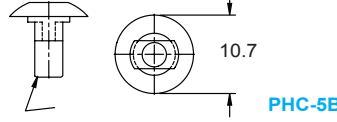

PHC-5B

RCCN 日成UC型配线固定钮 Cable Clamp



材 质：UL合格之NYLON66(本色),防火等级94V-2。

使用方法：将电缆套入钮环中(如附图),再以螺丝固定。

用 途：电机、电子、冷气配线之固定用

另备UC M5固定孔型号,详见网站增加数据。

Material：UL approved NYLON 66(natural), fireproof 94V-2

单位/Unit:mm

型号	Item No.	螺丝孔 Thread hole		宽度 Width	束线径(内径) Band dia.(inner)	长度 Length	厚度 Thickness	包装 Packing
本色 Natural	黑色 Black	A	B	C	D	E	F	
UC-0	UC-0B	4.8	8.0	9.6	3.1(1/8")1分	17	1.2	每包 Pcs/bag 100pcs
UC-0.5	UC-0.5B	4.8	9.2	9.6	5.0(3/16")分半	18.6	1.2	
UC-1	UC-1B	4.6	10.0	10.0	6.35(1/4")2分	20.0	1.3	
UC-1.5	UC-1.5B	4.6	12.0	10.0	7.9(5/16")2分半	22.0	1.3	
UC-2	UC-2B	4.6	12.5	12.0	9.5(3/8")3分	24.0	1.4	
UC-3	UC-3B	4.6	15.2	12.0	12.7(1/2")4分	31.0	1.5	
UC-4	UC-4B	4.6	18.2	12.0	15.8(5/8")5分	34.3	1.5	
UC-5	UC-5B	4.6	18.2	12.0	19.4(3/4")6分	36.0	1.5	
UC-6	UC-6B	4.6	22.0	12.0	25.4(1")1寸	43.0	1.6	
UC-6.5	UC-6.5B	4.6	24.0	12.0	27.5(1 1/16")	52	1.6	
UC-7	UC-7B	4.6	26.2	12.0	31.8(1 1/4")1寸2分	52	1.7	
UC-9	UC-9B	4.6	30.0	12.0	36.7(1 1/2")1寸4分	60	1.7	

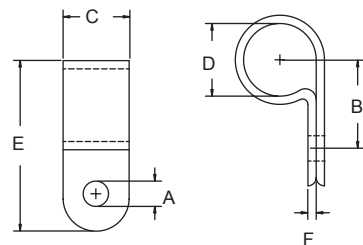

本系列阻燃V0型号,例:UC-2V0, UC-2BV0